



electronic powersolutions

CFM400S SERIES 400 WATT AC-DC POWER SUPPLY WITH PFC

Features

- Universal Input Range 80~264V_{ac}
- High Efficiency up to 94%
- 3"x 5" Compact Size
- Class I
- No Load Power Consumption<0.5W (PS-Off)
- Approval IEC/EN/UL 62368-1
- Approval EN 55032, 47 CFR FCC Part 15
- Active PFC Meets EN 61000-3-2
- Meets IEC/EN 60335-1
- High Power Density up to 17.3W/Inch³
- 370W Natural, 400W Conduction Convection
- Over Temperature Protection
- PS On/Off Remote Control
- Power Good & Power Fail Signal
- +5V Stand-by, 12V Fan Output
- Low Inrush Current



MODEL NUMBER	OUTPUT VOLTAGE	OUTPUT CURRENT			VOLTAGE ACCURACY	RIPPLE & NOISE	VOLTAGE ADJ. RANGE	LINE REGULATION	LOAD REGULATION	%EFF. (Typ.)
		NOTE1		NOTE2						
		With FAN	Without FAN							
			COVER	OPEN						
CFM400S120	12 V	33.33 A	26.67 A	23.33 A	±1%	120 mV	11.4~12.6 V	±0.5%	±1%	92%
CFM400S180	18 V	22.22 A	17.78 A	15.56 A	±1%	150 mV	17.1~18.9 V	±0.5%	±1%	93%
CFM400S240	24 V	16.67 A	13.33 A	11.67 A	±1%	150 mV	22.8~25.2 V	±0.5%	±1%	94%
CFM400S360	36 V	11.11 A	8.89 A	7.78 A	±1%	200 mV	34.2~37.8 V	±0.5%	±1%	94%
CFM400S480	48 V	8.33 A	6.67 A	5.83 A	±1%	250 mV	45.6~50.4 V	±0.5%	±1%	94%
CFM400S540	54 V	7.40 A	5.93 A	5.19 A	±1%	300 mV	51.3~56.7 V	±0.5%	±1%	94%
Stand-by Output Voltage										
All	+5 V	1A (Note 7)			±3%	100 mV	---	±1%	±5%	---
Fan Output Voltage										
All	+12 V	0.5A (Note 6)			---	---	---	---	---	---

Note:

1. V_{in}=230V_{ac}, Forced air convection with 21.9CFM fan.
2. Voltage accuracy is set at 100% full load and 25°C Ta.
3. Add a 0.1uF ceramic capacitor and a 10uF E.L. capacitor to output for ripple & noise measuring @20MHz BW.
4. Line regulation is measured from high line to low line with 100% full load.
5. Load regulation is measured from 10% to 100% full load.
6. Fan output can only operate normal when the stand-by output is above 0.5A.
7. When PS-OFF, at -40°C, stand-by output voltage with CC load 1A requires input voltage above 100V_{ac}.

PART NUMBER

Series	Number of Outputs	Nominal Output Voltage	Type	Output Terminal
CFM400	X	XXX	X (Option)	-X(Option)
CFM400	S : Single	120 : 12V 180 : 18V 240 : 24V 360 : 36V 480 : 48V 540 : 54V	None : With Baseplate C : With Cover	None : Vertical R : Horizontal

Part Number Example:

CFM400S120: With Baseplate, 400W, 12Vdc Output, Vertical Type Terminal

CFM400S120C-R: With Cover, 400W, 12Vdc Output, Horizontal Type Terminal

Specifications are subject to change without notice, E&OE, ALL PSU Terms & Conditions apply.

ALL PSU Ltd, Unit D6 Laser Quay, Culpeper Close, Medway City Estate,
Rochester, Kent, ME2 4HU, Tel : 01634 725527, Fax : 01634 739111
Email: sales@allpsu.co.uk, Web: www.allpsu.co.uk

REVISION: V10

**TECHNICAL SPECIFICATIONS**

(All specifications are typical at nominal input, full load at 25°C unless otherwise noted.)

ABSOLUTE MAXIMUM RATINGS

PARAMETER	NOTES and CONDITIONS	Device	Min.	Typ.	Max.	Units
Input Voltage	Safety only 90~264 V _{ac}	All	80		264	V _{ac}
Operating Temperature	See Derating Curve	All	-40		85	°C
Storage Temperature		All	-40		85	°C
Operating Altitude		All			5000	m

INPUT CHARACTERISTICS

PARAMETER	NOTES and CONDITIONS	Device	Min.	Typ.	Max.	Units
Operating Voltage Range		All	100		240	V _{ac}
Input Frequency Range	Safety 50-60HZ	All	47		63	Hz
Maximum Input Current	100% Full load, V _{in} =100V _{ac}	All			6	A
Power Factor	V _{in} =230V _{ac} Full load	All		0.95		
Leakage Current	Contact leakage current Earth leakage current	All			0.1 0.3	mA
Inrush Current	V _{in} =240V _{ac} , Cold start at 25°C	All		30		A

OUTPUT CHARACTERISTICS

PARAMETER	NOTES and CONDITIONS	Device	Min.	Typ.	Max.	Units
Output Voltage Set Point	V _{in} =Nominal V _{in} , I _o =I _o max., T _c =25°C	CFM400S120	11.88	12	12.12	V _{dc}
		CFM400S180	17.82	18	18.18	
		CFM400S240	23.76	24	24.24	
		CFM400S360	35.64	36	36.36	
		CFM400S480	47.52	48	48.48	
Operating Output Current Range	V _{in} =80V _{ac} ~264V _{ac} , See Derating Curve	CFM400S120			33.33	A
		CFM400S180			22.22	
		CFM400S240			16.67	
		CFM400S360			11.11	
		CFM400S480			8.33	
CFM400S540			7.40			
Holdup Time	V _{in} =115V _{ac}	All		10		ms
Output Voltage Regulation						
Load Regulation	10% to 100% full load	All			±1.0	%
Line Regulation	V _{in} =High line to low line	All			±0.5	%
Over Voltage Protection	Latch off (AC recycle to reset)	CFM400S120			16	V _{dc}
		CFM400S180			30	
		CFM400S240			35	
		CFM400S360			50	
		CFM400S480			63	
CFM400S540			63			
Over Current Protection	Auto recovery	All	110		190	%
Short Circuit Protection	Auto recovery	All				
Over Temperature Protection	Auto recovery	All				



CFM400S Series

PARAMETER	NOTES and CONDITIONS	Device	Min.	Typ.	Max.	Units
Output Ripple and Noise	1. Add a 0.1uF ceramic capacitor and a 10uF aluminum electrolytic capacitor to output 2. Oscilloscope is 20MHz bandwidth 3. Ambient temperature=25°C	CFM400S120			120	mV
		CFM400S180			150	
		CFM400S240			150	
		CFM400S360			200	
		CFM400S480			250	
		CFM400S540			300	
Load Capacitance	1. $V_{in}=115V_{ac}$ and $230V_{ac}$ 2. Output is 100% full load 3. Ambient temperature=25°C	CFM400S120			33330	uF
		CFM400S180			22220	
		CFM400S240			16670	
		CFM400S360			11110	
		CFM400S480			8330	
		CFM400S540			7400	
Efficiency	1. $V_{in}=230V_{ac}$ 2. Output is 100% full load 3. Ambient temperature=25°C	CFM400S120		92.0		%
		CFM400S180		93.0		
		CFM400S240		94.0		
		CFM400S360		94.0		
		CFM400S480		94.0		
		CFM400S540		94.0		
PS-On Signal	Power on	All	0		2	V_{dc}
	Power off (PS-ON and GND open)			4		mA
	Power on (PS-ON and GND short)			10		
	Power-off (PS-ON and GND open)			0		
Power Good (PG)	1. $V_{in}=80V_{ac}\sim 264V_{ac}$ 2. Output is 100% full load 3. The TTL goes high after power set up	All	100		500	ms
Power Fail (PF)	1. $V_{in}=80V_{ac}\sim 264V_{ac}$ 2. Output is 100% full load 3. The TTL goes low before V_o below 90% rated value	All	1	10		ms

ISOLATION CHARACTERISTICS

PARAMETER	NOTES and CONDITIONS	Device	Min.	Typ.	Max.	Units
Input to Output	1 minute	All	3000		4000	V_{ac}
Isolation Resistance	Input to output	All	100			MΩ

FEATURE CHARACTERISTICS

PARAMETER	NOTES and CONDITIONS	Device	Min.	Typ.	Max.	Units
Switching Frequency	$P_{out}=\text{max. rated power}$	All		65		kHz
Output Voltage adjustment		All	-5		+5	%

GENERAL SPECIFICATIONS

PARAMETER	NOTES and CONDITIONS	Device	Min.	Typ.	Max.	Units
MTBF	$I_o=100\%$; $T_a=25^\circ\text{C}$ per MIL-HDBK-217F	All		300		k hours
Humidity	Non-condensing	All			93	% RH
Shock	Meet MIL-STD-810F Table 516.5, Table 516.5-I 10ms, each axis 3 times ($\pm X$ 、 $\pm Y$ 、 $\pm Z$ axis)	All		75		g
Vibration	Meet MIL-STD-810F Table 514.5C-VIII, 15~2000Hz, X、Y、Z axis, 1 hour (each axis),. Total 3 hrs.	All		4		g

Specifications are subject to change without notice, E&OE. ALL PSU Terms & Conditions apply.



GENERAL SPECIFICATIONS

PARAMETER	NOTES and CONDITIONS	Device	Min.	Typ.	Max.	Units
Weight	Baseplate versions Covered versions	All		470 550		g
Dimensions	With baseplate C (with cover)	All	5.000x3.000x1.540 Inches (127.00x76.20x39.10 mm) 5.354x3.425x1.673 Inches (136.00x87.00x42.50 mm)			
Safety	Class I, EN/IEC/UL 62368-1					Ed3.0
EMC Emission	EN 55032:2015+A11:2020, EN 61000-6-3 2007+A1: 2011+AC: 2012, Class B EN IEC 61000-6-4:2019, 47 CFR FCC Part 15 Subpart B (Class B) EN IEC 61204-3:2018, EN IEC 61000-3-2:2019, EN 61000-3-3:2013+A1:2019					
Conducted Disturbance	EN 55032:2015+A11:2020, EN 61000-6-3 2007+A1: 2011+AC: 2012, Class B EN IEC 61000-6-4:2019, 47 CFR FCC Part 15 Subpart B (Class B), EN IEC 61204-3:2018					Class B
Radiated Disturbance	EN 55032:2015+A11:2020, EN 61000-6-3 2007+A1: 2011+AC: 2012, Class B EN IEC 61000-6-4:2019, 47 CFR FCC Part 15 Subpart B (Class B), EN IEC 61204-3:2018					Class B
Harmonic Current Emissions	EN IEC 61000-3-2:2019					Class A, C
Voltage Fluctuations & Flicker	EN 61000-3-3:2013+A1:2019					
EMC Immunity	EN 55035:2017+A11:2020, EN IEC 61000-6-1:2019, EN IEC 61000-6-2:2019 EN IEC 61204-3:2018, IEC 61000-4-2, 3, 4, 5, 6, 8, 11					
Electrostatic Discharge (ESD)	IEC 61000-4-2:2008, Air Discharge: ±8kV, Contact Discharge: ±4kV					Criterion A
Radio-Frequency, Continuous Radiated Disturbance	IEC 61000-4-3:2020					Criterion A
Electrical Fast Transient (EFT)	IEC 61000-4-4:2012, ±1kV, ±2kV					Criterion A
Surge	IEC 61000-4-5:2014+A1:2017, L-N: ±0.5kV, ±1kV, L-E(Ground): ±0.5kV, ±1kV, ±2kV					Criterion A
Conducted Disturbances, Induced by RF Fields	IEC 61000-4-6:2013+COR1:2015					Criterion A
Power Frequency Magnetic Field	IEC 61000-4-8:2009					Criterion A
Voltage Dips	IEC 61000-4-11:2020, Dip: 30% Reduction, Dip >95% Reduction					Criterion A
Voltage Interruptions	IEC 61000-4-11:2020, >95% Reduction					Criterion B
Application Note Link	CFM400S Series App Notes					



CHARACTERISTIC CURVE

Power Derating Curve

Forced Air Flow

Output power & Input voltage

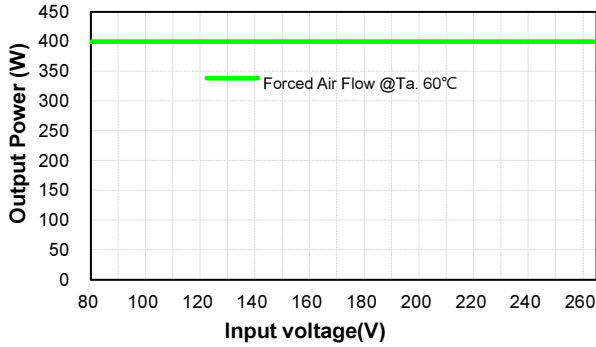

Forced Air Flow

Output power vs Ambient Temperature

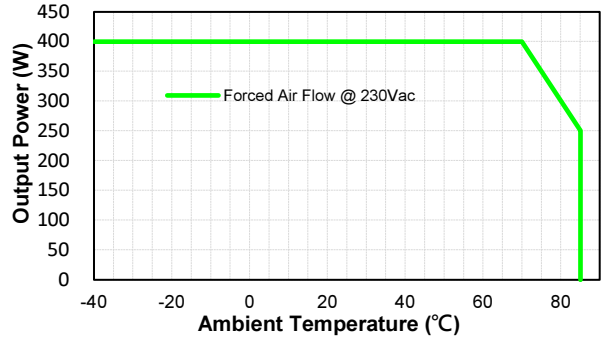

Natural Convection

Output power & Input Voltage

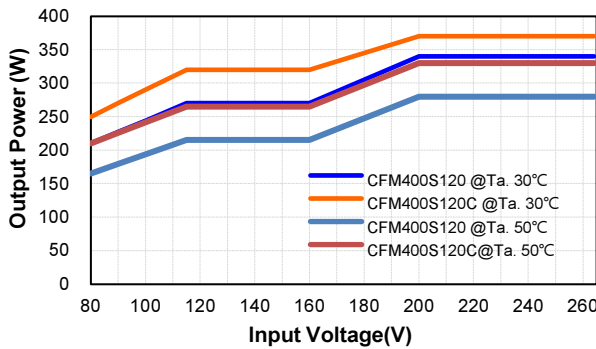

Natural Convection

Output power vs Ambient Temperature

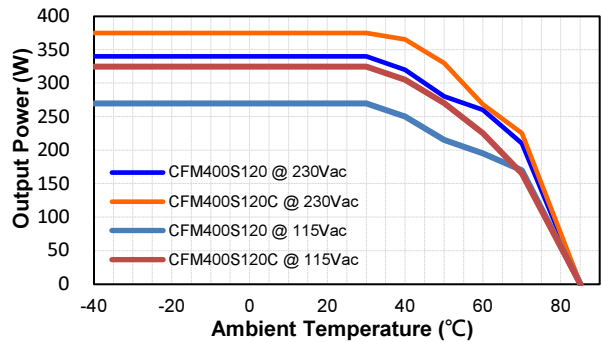

Output power & Input Voltage

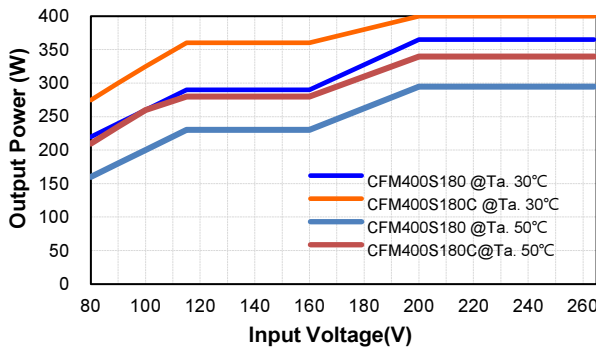

Output power vs Ambient Temperature

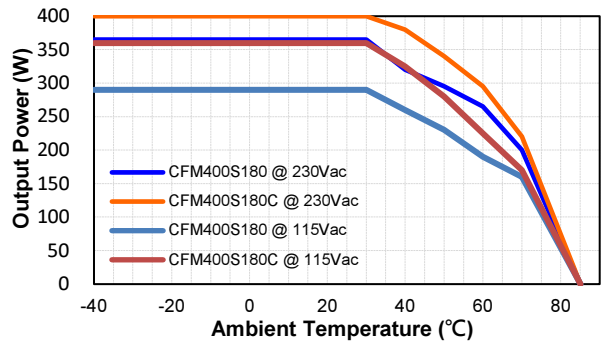



CFM400S Series

Output power & Input Voltage

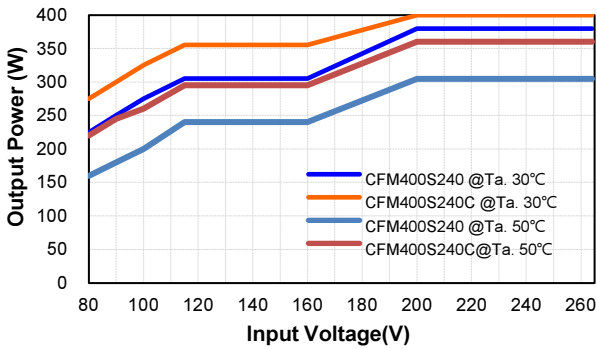

Output power vs Ambient Temperature

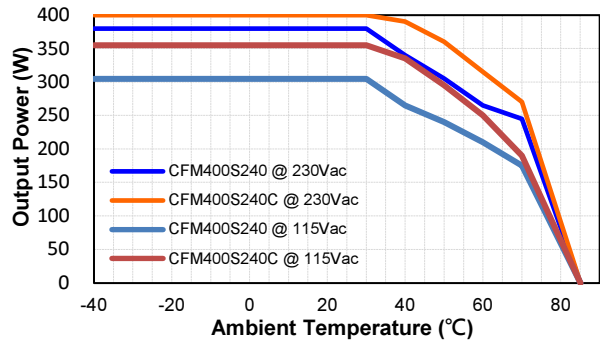

Output power & Input Voltage

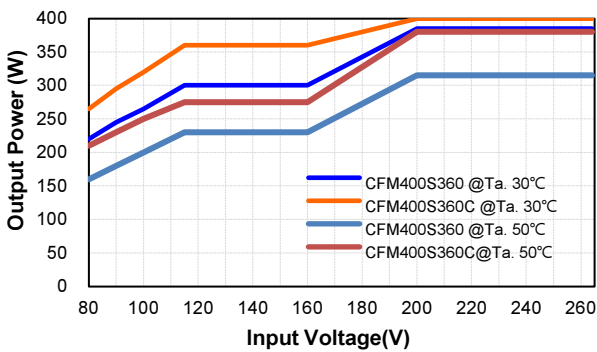

Output power vs Ambient Temperature

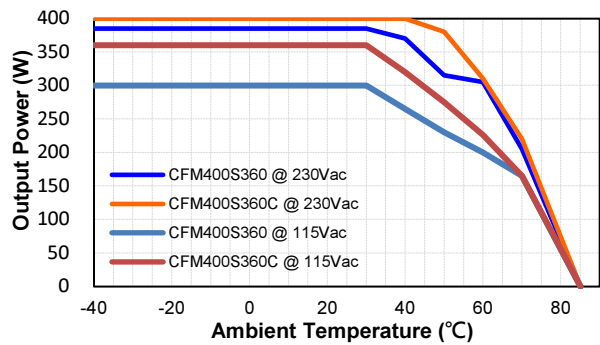

Output power & Input Voltage

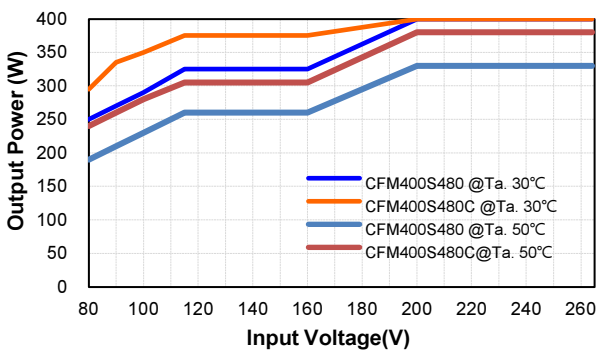

Output power vs Ambient Temperature

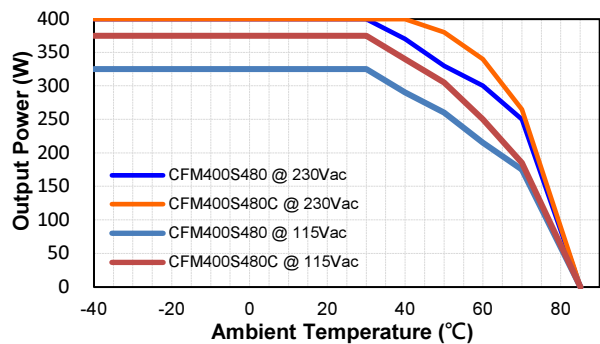

Output power & Input Voltage

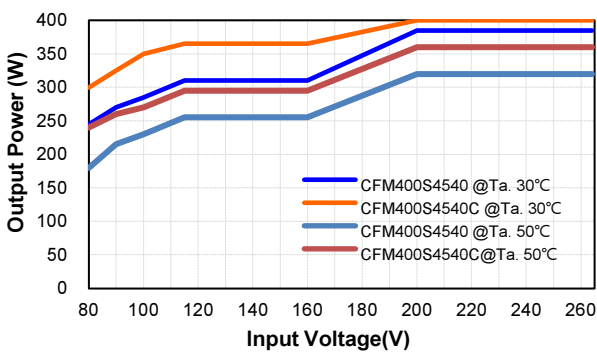

Output power vs Ambient Temperature

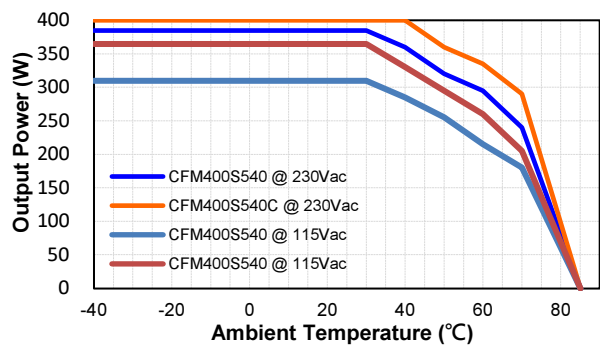

Specifications are subject to change without notice, E&OE. ALL PSU Terms & Conditions apply.

ALL PSU Ltd, Unit D6 Laser Quay, Culpeper Close, Medway City Estate,
Rochester, Kent, ME2 4HU, Tel : 01634 725527, Fax : 01634 739111
Email: sales@allpsu.co.uk, Web: www.allpsu.co.uk



CFM400S Series

Conduction Convection with External Baseplate (48x24.8x0.12cm)

Conduction Convection with External Baseplate (48x24.8x0.12cm)

Output power & Input Voltage

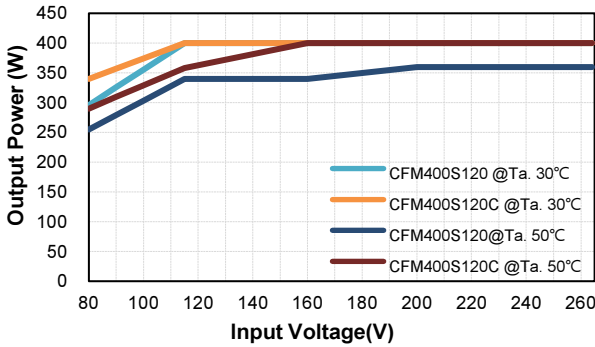

Output power vs Ambient Temperature

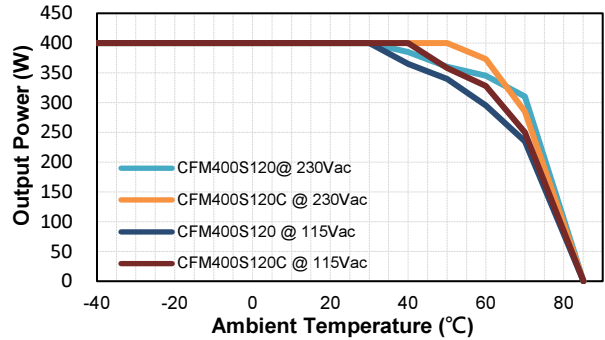

Output power & Input Voltage

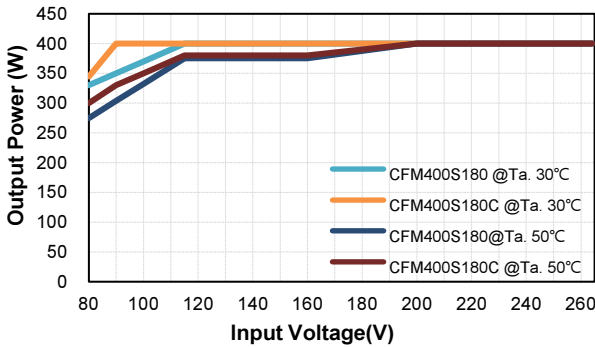

Output power vs Ambient Temperature

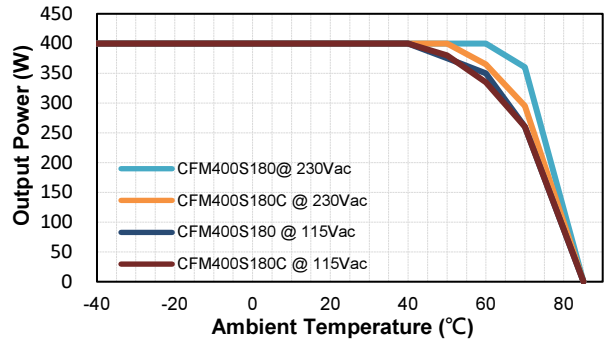

Output power & Input Voltage

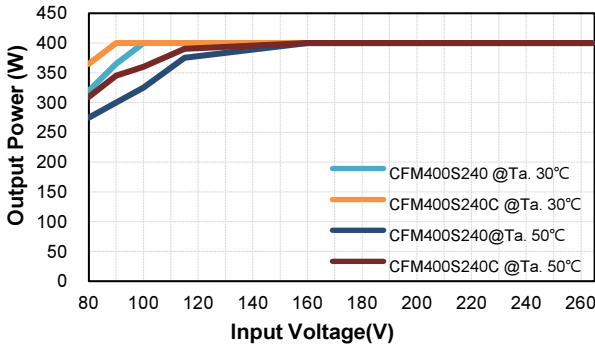

Output power vs Ambient Temperature

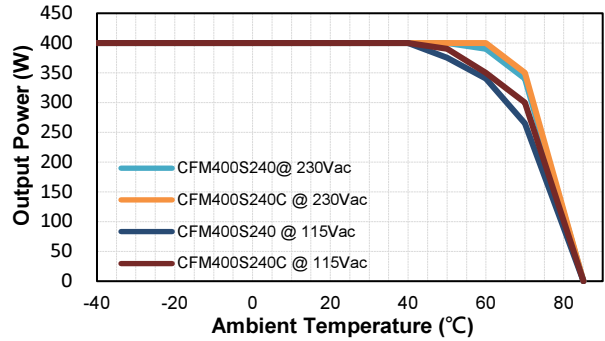

Output power & Input Voltage

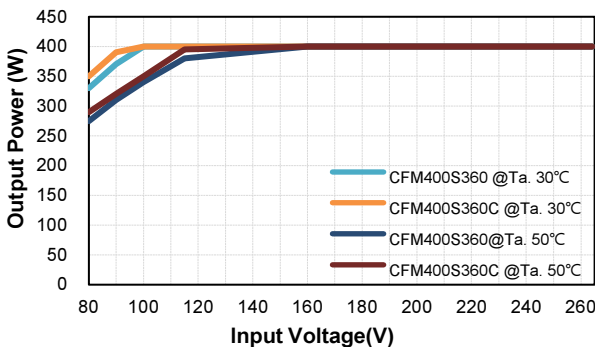

Output power vs Ambient Temperature

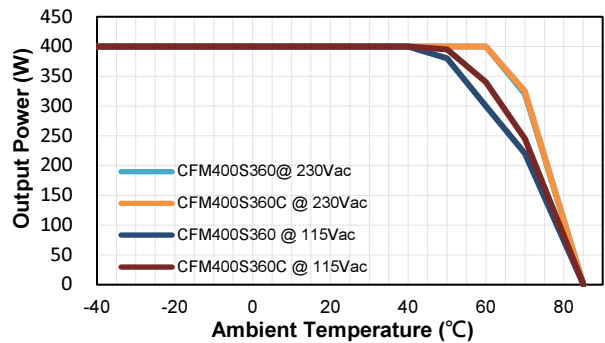

Specifications are subject to change without notice, E&OE. ALL PSU Terms & Conditions apply.

ALL PSU Ltd, Unit D6 Laser Quay, Culpeper Close, Medway City Estate,
Rochester, Kent, ME2 4HU, Tel : 01634 725527, Fax : 01634 739111
Email: sales@allpsu.co.uk, Web: www.allpsu.co.uk

REVISION: V10



CFM400S Series

Output power & Input Voltage

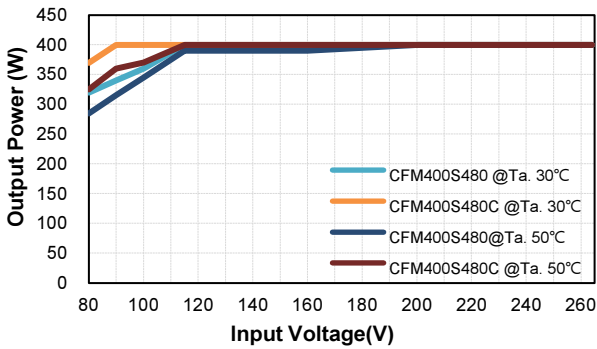

Output power vs Ambient Temperature

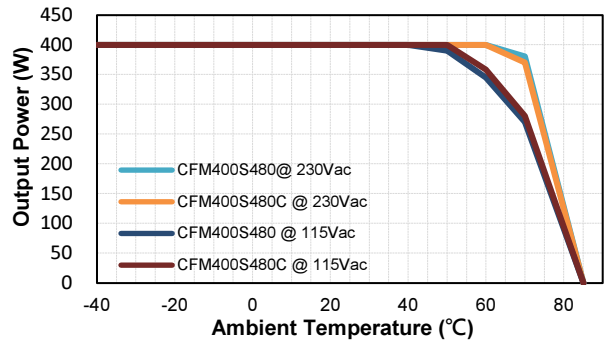

Output power & Input Voltage

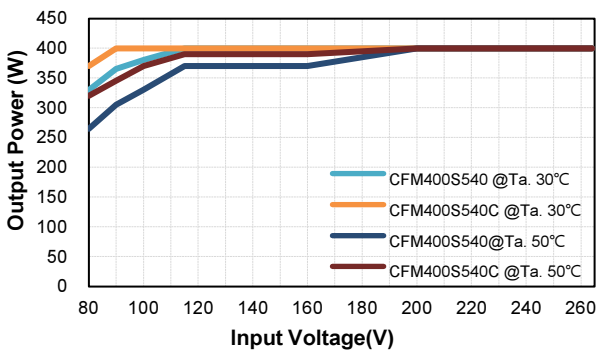

Output power vs Ambient Temperature

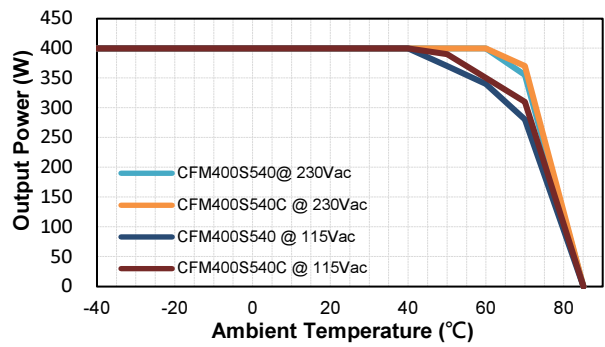

Performance Data

CFM400S120 (Eff Vs Io)

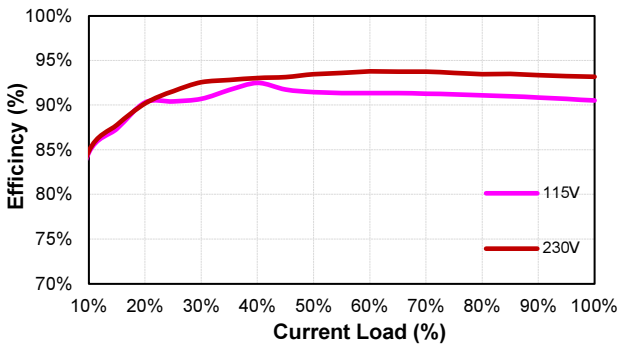

CFM400S180 (Eff Vs Io)

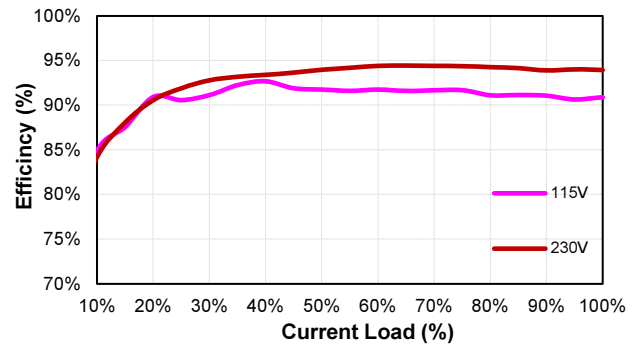

CFM400S240 (Eff Vs Io)

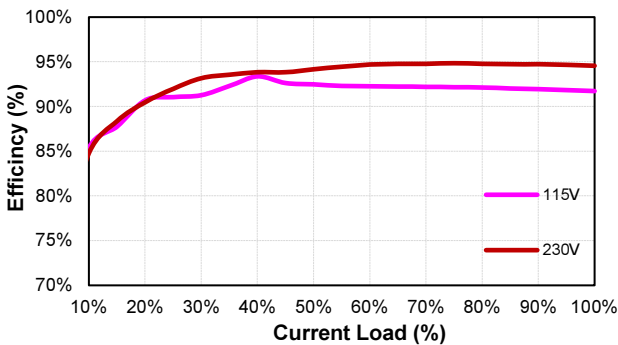

CFM400S360 (Eff Vs Io)

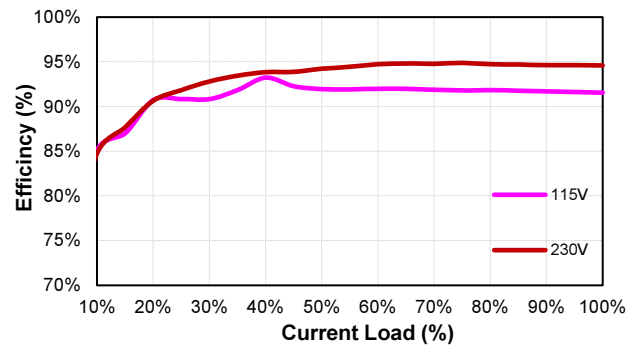

Specifications are subject to change without notice, E&OE. ALL PSU Terms & Conditions apply.

ALL PSU Ltd, Unit D6 Laser Quay, Culpeper Close, Medway City Estate,
Rochester, Kent, ME2 4HU, Tel : 01634 725527, Fax : 01634 739111
Email: sales@allpsu.co.uk, Web: www.allpsu.co.uk



CFM400S Series

CFM400S480 (Eff Vs Io)

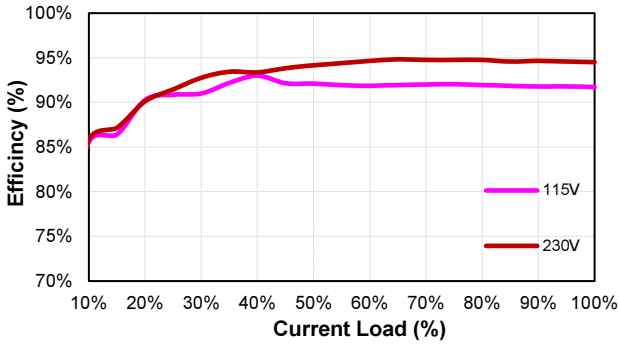

CFM400S540 (Eff Vs Io)

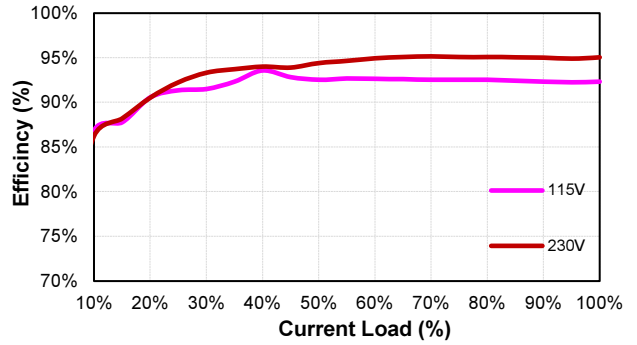

MECHANICAL SPECIFICATION

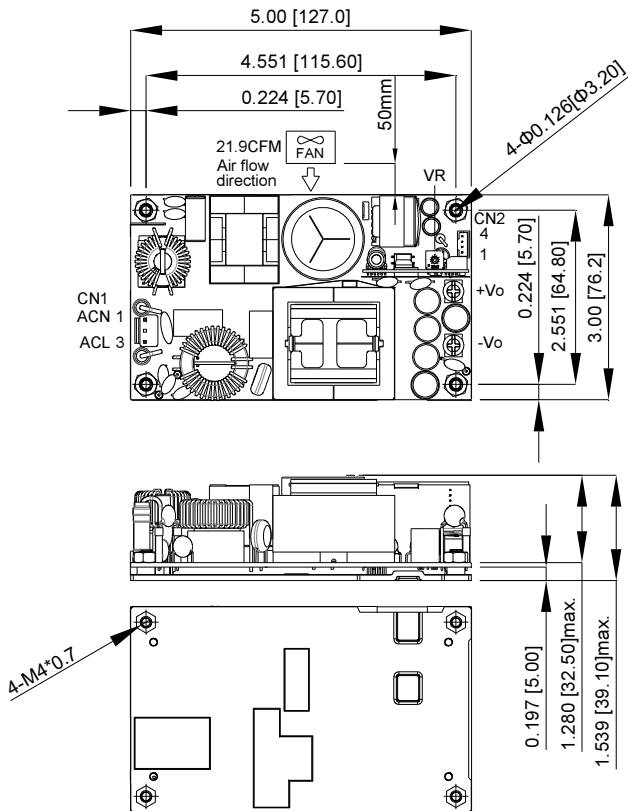

CFM400SXXX

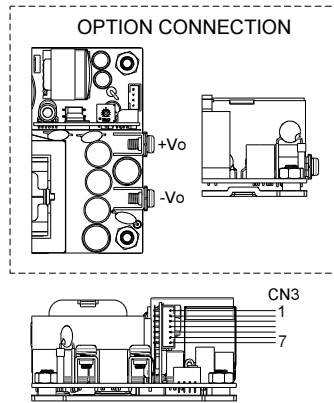

PIN CONNECTION		
PIN	Function	Wafer
1	ACN	CN1
2	-	
3	ACL	CN2
1	GND	
2	+5VSB	
3	GND	CN3
4	+12V-FAN	
1	GND	
2	PF	
3	FAN-EN	
4	PS-ON	
5	-Sense	
6	+Sense	
7	OPTION	

All Dimensions In Inches[mm]
 Tolerance Inches: x.xx = ± 0.03, x.xxx = ± 0.02
 Millimeters: x.x = ± 0.7, x.xx = ± 0.5

Specifications are subject to change without notice, E&OE. ALL PSU Terms & Conditions apply.

ALL PSU Ltd, Unit D6 Laser Quay, Culpeper Close, Medway City Estate,
 Rochester, Kent, ME2 4HU, Tel : 01634 725527, Fax : 01634 739111
 Email: sales@allpsu.co.uk, Web: www.allpsu.co.uk



MECHANICAL SPECIFICATION

CFM400SXXXC

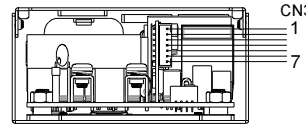
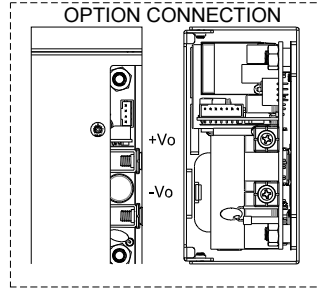
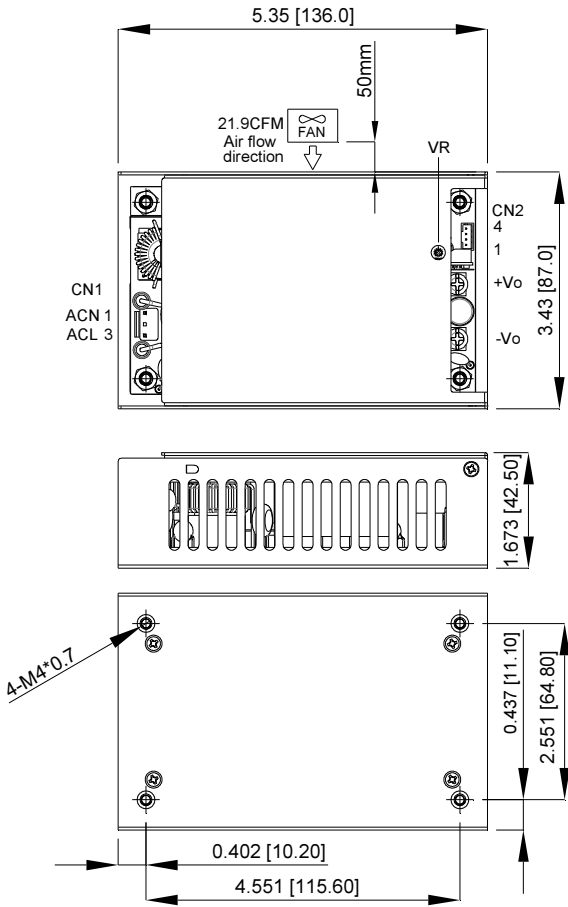

PIN CONNECTION		
PIN	Function	Wafer
1	ACN	CN1
2	-	
3	ACL	
1	GND	CN2
2	+5VSB	
3	GND	
4	+12V-FAN	
1	GND	CN3
2	PF	
3	FAN-EN	
4	PS-ON	
5	-Sense	
6	+Sense	
7	OPTION	

All Dimensions In Inches[mm]
 Tolerance Inches: x.xx = ± 0.03, x.xxx = ± 0.02
 Millimeters: x.x = ± 0.7, x.xx = ± 0.5